



MP 500
Power Supply

Instruction Manual

Catalog MP-500

Packing list

MP-500:

- 1 x MP 500 Power Supply
- 1 x Power Cord for MP power supply
- 1 x Extra fuse inside power plug on the rare of unit
- 1 x MP 500 power supply instruction manual

Table of Contents

Packing list	2
Warning	4
Safety Information	5
Product Specifications	7
Product Description	8
Introduction	9
Overview	9
Controls and Features	10
Installation Instructions	11
Operation Instructions	11
Troubleshooting	19
Maintenance	22
Ordering information	22
Warranty	24

Warning

The MP-500 power supply has been tested and found to comply with the limits for CE regulation. These limits are designed to provide reasonable protection against harmful interference when the equipment is operated in a laboratory environment. This power supply generates, uses, and can radiate radio frequency energy, and if not installed and used in accordance with the instruction manual, may cause harmful interference to radio communications. Operation of this power supply in a residential area is likely to cause harmful interference in which case the user will be required to correct the interference at their expense. Changes or modifications not expressly approved by the party responsible for compliance could void the user's authority to operate the equipment. It is strongly recommended the user to read carefully the following points before this equipment is operated.

1. Read and follow carefully the manual instructions.
2. Do not alter the power supply. Failure to adhere to these directions could result in personal and/ or laboratory hazards, as well as invalidate the equipment warranty.
3. Use a properly grounded electrical outlet of correct voltage and current handling capacity.
4. Disconnect from the power supply before maintenance and servicing. Refer servicing to qualified personnel.
5. If solution is accidentally spilled into the instrument, disconnect the grounded plug and the user must carry out the advised procedure or contact Cleaver Scientific or their representative. Replace damaged parts.
6. Do not use in the presence of flammable or combustible material; fire or explosion may result. This device contains components, which may ignite such materials.
7. Refer maintenance and servicing to qualified personnel.
8. Ensure that the system is connected to an electrical supply according to local and national electrical codes. Failure to properly connect this power supply may create a fire or shock hazard.
9. Ensure correct operation to avoid possible hazards of explosion, implosion or release of toxic or flammable gases arising from the materials being heated.
10. The unit must be operated **Only** by qualified personnel.

Safety Information

This power supply must be used with a high level of precautions.

Before connecting with the electrical supply, check the supply voltage is within the range stated on the rating label, and this device must be earthed. Place the unit in a safe and dry location not in contact with objects in the surrounding area. Also do follow the safety precautions for chemicals and dangerous materials. If needed, please contact a qualified service representative.

Environmental Conditions

Ensure the instrument is installed and operated strictly in the following conditions:

- ≤95% RH,
- 75 KPa-106 Kpa,
- Altitude not to exceed 2000 meters
- Ambient ~ 40°C operating temperature.

Avoiding Electrical Shock

Follow the guidelines below to ensure safe operation of the unit.

The MP-500 power supply has been designed for use with shielded wires thus minimizing any potential shock hazard to the user.

Cleaver Scientific recommends against the use of unshielded wires.

To avoid electrical shock:

1. The power supply must not be wet. It must be completely dry.
2. NEVER connect or disconnect wire leads from the power jacks when the red indicator light at the Start/Stop key is lit.
3. WAIT at least 5 seconds after stopping a run before handling output leads or connected apparatus.
4. ALWAYS make sure that hands, work area, and instruments are **clean** and **dry** before making any connections or operating the power supply.
5. ONLY connect the power cord to a properly 3-prong grounded AC outlet, using the power cord provided with the power supply.

Avoiding Damage to the Instrument

1. Do not attempt to operate the device if damaged in any way.
2. Protect this unit from physical damage, corrosive agents and extreme temperatures (direct sunlight etc).
3. For proper ventilation and safety, leave at least 10 cm of space behind the instrument, and at least 5 cm of space on each side.
4. Do not operate the power supply in high humidity environments (> 95%), or where condensation may occur.
5. When the MP-500 power supply is taken into a cold room environment, the unit can be operated immediately. However, when the MP-500 power supply is removed from the cold room environment, let the unit equilibrate to room temperature for a minimum of 2 hours before using it.
6. Before using any cleaning or decontamination solutions except those recommended by the manufacturer, users should check with the manufacturer that the proposed method will not damage the equipment.

Equipment Operation

Follow the guidelines below to ensure safe operation of the unit:

1. It must be checked that the displayed figures are in normal function for use before using this unit.
2. NEVER access any HAZARDOUS LIVE parts.

Symbols

The symbol used on the MP-500 Power Supply is explained below.



Used on the MP-500 Power Supply to indicate an area where a potential shock hazard may exist.

Used on the MP-500 Power Supply to indicate a warning. Consult the manual to avoid possible personal injury or instrument damage.

Product Specifications

Output Voltage / Inc	5-500V / 1V
Output Current / Inc	10-600mA / 10mA
Max. Watt	300W / 1W
Operating Constants	Voltage or Current or Power
Control	Microprocessor Controller
Program Storage	30 programmed files
Program Multi-Step	Up to 6 steps
Terminator Pairs	4 pairs
LCD Display	2.6"
Timer	1~9999 mins with alarm, continuous
Safety Device	No Load detection Leakage detection Overload detection Over temperature protection Shrouded plugs and sockets
Automatic Crossover	Yes
Operating Temperature	Ambient - 40 °C
Unit Dimension	190 x 290 x 95 mm (W x L x H)
Construction Material	Flame retardant ABS faceplate and aluminum
Rated Voltages	100 – 240 Volt / 50- 60 Hz
Weight	2.5 kg

Product Description

The Cleaver Scientific MP-500 power supply is a microprocessor controlled power supply designed to meet most electrophoresis needs in a personal, single, easy to use unit. This manual describes the setup and operation of the MP-500 Power Supply including important information on safety and maintenance of the unit. The MP-500 power supply is capable of running horizontal & vertical electrophoresis, SDS-PAGE, native PAGE applications, and two-dimensional electrophoresis, and electro-blotting. In addition, a Timer with alarm function is also equipped in the unit, and so is a Pause function. Furthermore, the powerful specifications plus four pairs of terminator pairs can be used for multi electrophoresis units simultaneously.

The Cleaver Scientific MP-500 power supply provides Constant Voltage or Constant Current or Constant Power to instruments used in electrophoresis. 4 pairs of terminals and the powerful specification provided enable the maximum capability of the MP-500 power supply compared to other existing similar products on the market. The MP-500 also has a 2.6" LCD screen where many parameters are shown on the same display, which provides a better view to the end user.

Features of The MP-500 power supply:

- Compact size
- Advanced capacity: 300W, 600mA, 500V
- Microprocessor controller
- Constant voltages, constant currents and constant power
- Four pairs of outlet terminator
- LCD display
- Timer with alarm function
- Advanced safety devices
- Stackable
- Wide applications for DNA, RNA and protein electrophoresis

Introduction

Overview

The MP-500 Power Supply is recognized as one of the most advanced high current power supplies equipped with outstanding specifications to cover the majority of electrophoresis applications on the market. Sufficient and accurate output voltages, four pairs of terminals, compact size and CE compliance for safety can deliver accurate and reliable experimental results from one experiment to another.



Rear of Unit







Controls and Features

Please refer to Figures on the following page for the location of the following controls and features.

Front Control Panel

1.  **Key** - to move the cursor up between parameters and to increase numeric values
2.  **Key** - to move the cursor down between parameters and to decrease numeric values
3.  **Key** - to move the cursor left forward between parameters

4.  **Key** - to move the cursor right forward between parameters
5.  **Key** – to select either Constant Voltage or Constant Current mode or Time
6.  **Key** – to enter the numeric value set up
7.  **Key** – to activate or stop the unit
8.  **Key** – to temporarily interrupt power to an operation in progress without terminating electrophoresis and to resume power after pausing without resetting the timer.

Installation Instructions

The MP-500 Power Supply is actually an already installed instrument. As long as it is placed on a sturdy and level surface in a safe, dry place, and connected with a well-prepared electrophoresis system, it is ready for operation.

Operation Instructions

Introduction

The MP-500 Power Supply is designed to operate under two modes, **Constant Mode or Programming Mode**, depending upon your electrophoresis needs. Use the **Constant Voltage / Current / Power Operation** for applications that require only one specific voltage limit, current limit, and power limit continuously during the entire duration of electrophoresis.

Display Screen



The  is the display screen to appear after turning on the power to your instrument. You can choose the operational Mode (**Constant** or **Program**) on the **downward** side of the display screen.

- Afterwards, on the **Display Screen**, you would select :

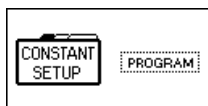

- either Constant Setup:



- or Program Setup:

Constant Setup Operation



Introduction



Instructions for operating MP 500 Power Supply in the **Constant Operation** are provided in this section. The **Constant Voltage / Current / Power Mode** allows you to specify a voltage limit, and current limit to be used continuously during the entire duration of electrophoresis. Review the guidelines provided in this manual before starting electrophoresis. We recommend reading the guidelines provided in this manual for best results before starting an operation.





1. Place the MP-500 Power Supply on a sturdy and level surface in a safe, dry place, away from laboratory traffic.
2. Ensure that the AC power switch is OFF, and then plug the three-pronged power cord into a grounded three-prong AC outlet of the appropriate voltage (110V to 240V as indicated on the rating sticker near the AC cord on the back of the unit).
3. Connect the DC output jacks from the electrophoresis unit; insert the red lead (+) into the red output jack, and the black lead (-) into the black output jack.

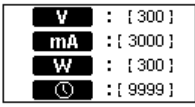

4. Use the power switch on the rear of the instrument to turn on the power

Supply. The  will appear on the screen.

5. Use  Key and  Key to select , and then press



 Key or  Key to enter the next screen, .

6. Use  Key,  Key,  Key and  Key to move cursor to the parameter, for instance voltage (V) or current (mA) or power (W) or Time (Minute), press  Key to set the specified parameter.



7. Use  Key,  Key to set the appropriate value, and then press  Key, and move to the next parameter until all the parameters are set in the same operation method.

8. Press  Key to start electrophoresis, , the LED is lit, and the

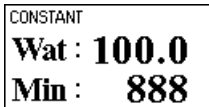
screen will show the real time parameter values, , and

press  Key or  Key to see the following screen, .



Press  Key or  Key back to .

9. Press  Key to temporarily interrupt power to ongoing electrophoresis without terminating the operation, , the LED is flashing. Press  Key to restart the run.

10. Press the  Key again to stop electrophoresis.

11. When the run is complete, the operation stops with alarm and





 is shown on the screen. Press  Key to terminate a timed run, and Turn the AC power OFF by the switch on the rear.

12. To change Limits of Electrophoresis in Progress

If you need to make changes to the current running limits, you must stop

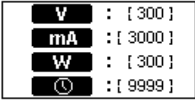
electrophoresis by pressing the  Key. Press  Key to enter the

setting screen, . Enter the changes and then press  Key once again to restart your operation.

Note: After stopping and restarting an operation, the timer resets to the selected time and does not take into account the time that electrophoresis was in progress before it was stopped.







Programming Setup Operation



Introduction

Instructions for operating the MP-500 Power Supply in the **Programming Operation** are provided in this section. The **Programmable Mode** allows you to vary levels in voltage (V), current (mA), and power (W) during specified periods of time as discrete changes (STEP) or as gradients (RAMP) for up to 6 Steps, depending upon your electrophoresis needs. The MP-500 power supply is capable of having 30 different program files stored for the user's convenience. We recommend reading the guidelines provided in this manual for best results before starting an operation.

1. Place The MP-500 Power Supply on a sturdy and level surface in a safe, dry place, away from laboratory traffic.
2. Ensure that the AC power switch is OFF, and then plug the three-pronged power cord into a grounded three-prong AC outlet of the appropriate voltage (110V to 240V as indicated on the rating sticker near the AC cord on the back of the unit).
3. Connect the DC output jacks from the electrophoresis unit; insert the red lead (+) into the red output jack, and the black lead (-) into the black output jack.
4. Use the power switch on the rear of the instrument to turn on the MP-500





Power Supply. The  will appear on the screen.



5. Use  Key and  Key to select , and then press  Key or  Key to enter the next screen, .

6. Press  Key first and then use  Key,  Key to select appropriate file number, and then press  Key to enter the following

screen,

F	V	mA	W	⌚
1	{100}	800	300	60
2	200	800	300	60
3	300	800	300	60

7. Use  Key,  Key,  Key and  Key to move the cursor to the parameter, for instance voltage (V) or current (mA) or power (W) or Time (Minute), press  Key to set the specified parameter.

8. Use  Key,  Key to set the appropriate value, and then press  Key, and move to the next parameter until all the parameters are set in the same operation method.

9. Use  Key to move down to

F	V	mA	W	⌚
4	{100}	800	300	60
5	200	800	300	60
6	300	800	300	60

 for setting Step 4-6. Press

 Key back to Step 1-3 screen,

F	V	mA	W	⌚
1	{100}	800	300	60
2	200	800	300	60
3	300	800	300	60

.

10. Press  Key to start electrophoresis,  , the LED is lit, and the

screen will show the real time parameter values,



PROGRAM File: 01 Step: 1
Volt : 300
mA : 2000

, and press

 Key or  Key to see the following screen,

PROGRAM File: 01 Step: 1
Wat : 100.0
Min : 888

. Press

 Key or  Key back to

PROGRAM File: 01 Step: 1
Volt : 300
mA : 2000

.

11. Press  Key to temporarily interrupt power to ongoing run without terminating the operation, , the LED is flashing. Press  Key to restart the run.

12. When electrophoresis is completed,  is shown on the screen.

Press the  Key again to stop electrophoresis.

13. To change Limits of Electrophoresis in Progress

If you need to make changes to the current running limits, you must stop

electrophoresis by pressing the  Key. Press  Key to enter the

setting screen,

#	V	mA	W	⌚
1	100	800	300	60
2	200	800	300	60
3	300	800	300	60

. Enter the changes and then press 

Key once again to restart your operation.

Note: After stopping and restarting an operation, the timer resets to selected time and does not take into account the time that electrophoresis was in progress before it was stopped.

Limiting The Parameter Setting

Introduction

The MP-500 Power Supply is capable of operating at limiting voltage, or limiting Current, or limiting power irrespective of the Constant Setup mode or Programming Setup mode. We use Programming Setup mode as an example.

Voltage Limiting

1. Use  Key,  Key,  Key,  Key, and  Key to set Maximum Current (600mA) and Maximum Power (300W), and on the real

time screen “Volt” is shown in hollow type, for instance,

PROGRAM File : 01 Step : 1
Volt : 300
mA : 2000

Current Limiting

1. Use  Key,  Key,  Key,  Key, and  Key to set Maximum Voltage (600V) and Maximum Power (300W), and on the real

time screen “mA” is shown in hollow type, for instance,

PROGRAM File : 01 Step : 1
Volt : 300
mA : 2000

Power Limiting

1. Use  Key,  Key,  Key,  Key, and  Key to set Maximum Voltage (500V) and Maximum Current (600mA), and on the real





time screen “Wat” is shown in hollow type, for instance,

PROGRAM File : 01 Step : 1
Wat : 100.0
Min : 888

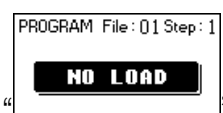
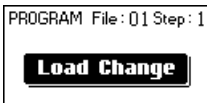
Troubleshooting Guide

Many operating problems may be solved by carefully reading and following the instructions in this manual. Some suggestions for troubleshooting are given below. Should these suggestions not resolve the problem, contact our SERVICE DEPARTMENT or a distributor in your region for assistance. If troubleshooting service is required, please include a full description of the problem.

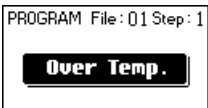
Problem	Cause	Solution
No Display / lights	No AC power	Check if MP power supply is unplugged, or there is an AC power source problem
	AC power cord is not connected	Check AC power cord connections at both ends. Use the correct cords.
	The fuse has blown	Replace the fuse
Repeated fuse blown	Hardware failure	Contact Cleaver Scientific service department
Operation stops with alarm: The screen displays 	Electrophoresis leads are not connected to the power supply or to the electrophoresis unit(s), or there is a broken circuit in the electrophoresis cell	Check the connections to the power supply and on your electrophoresis cell to make sure the connection is intact; check condition of wires in electrophoresis unit. Close the circuit by reconnecting the cables. Press START/STOP to restart the run.
	High resistance due to tape left on a pre-cast gel, incorrect buffer concentration, or incorrect buffer volumes in the electrophoresis cell	Correct the condition by making sure the tape is removed from the pre-cast gel, buffers are prepared correctly, and the recommended volume of buffer is added to the electrophoresis unit.
Operation stops with alarm: Display shows 	Bad connections for terminal connectors or damaged wires or damaged platinum wires	Check all the connections to terminators, cables, wires, and gel tanks

<p>Operation stops with alarm: Display shows</p> 	<p>Circuit is interrupted</p>	<ul style="list-style-type: none"> - Verify that the running buffer is correct. - Verify that all cables are attached correctly - Turn the Power switch off and on again; restart application. - If you cannot restart the instrument, turn off the power, disconnect the power cord from the outlet, and contact Technical Service.
<p>Operation stops with alarm: Display shows</p> 	<p>Circuit is interrupted</p>	<ul style="list-style-type: none"> - Verify that the running buffer is correct. - Verify that all cables are attached correctly - Turn the Power switch off and on again; restart application. - If you cannot restart the instrument, turn off the power, disconnect the power cord from the outlet, and contact Technical Service.
<p>Operation stops with alarm: Display shows</p> 	<p>Ground leak detected during run</p>	<p>Check the electrophoresis system for improper grounding. Restart the power supply by turning the Power switch off and on.</p>
<p>Operation stops with alarm: Display shows</p> 	<p>Power supply is overheating</p>	<ul style="list-style-type: none"> - Turn off power supply. Check for sufficient airflow around the power supply fan. After cooling down, restart the power supply by turning the Power switch to the on position. - If you cannot restart the instrument, turn off the power, disconnect the power cord from the outlet, and contact Technical Service.
<p>Operation stops with alarm: Display shows</p>  <p>and countdown</p>	<p>Power supply will restart in 9 seconds.</p>	<ul style="list-style-type: none"> - Verify that the electrophoresis condition and system is correct. - Pay attention to personal safety.

Encountering Problems

1. Check the troubleshooting section.
2. Call Technical Service
3. If the unit must be shipped back for repair, contact Cleaver Scientific or the distributor for a Return Authorization Number and shipping instructions. The unit will be repaired or replaced as quickly as possible and returned to you.

Replacing the Fuse

For additional fuses, contact Cleaver Scientific Ltd. to replace the fuse:

1. Turn off the main power switch at the rear of the Power Supply and detach the power cord.
2. Open the fuse compartment located inside the Power Entry Module by inserting a small flat blade screwdriver into the slot below the ON/OFF switch. Turn the screwdriver to gently pry open the fuse compartment.

Note: The fuse compartment will not open with the power cord in place.

3. Pull the fuse holder out of the compartment and inspect the fuse. If the fuse is burned or there is a break in the fuse element, replace the fuse with an identical type of fuse (4A/250V~) as provided in the fuse holder (see figure below).
4. Place the fuse holder back into the compartment.
5. Snap the cover closed.

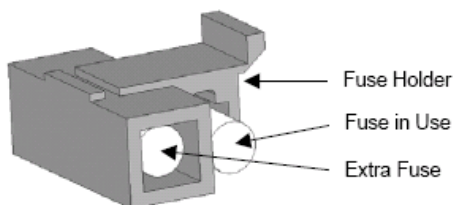

Maintenance

The MP-500 Power Supply uses all solid-state components and should require no maintenance or recalibration under normal use. The housing may be cleaned with a dry cloth. If the unit must be returned for repair, contact our **SERVICE DEPARTMENT** or your local distributor for shipping instruction.

Ordering Information

<i>Cat. No.</i>	<i>Description</i>
MP-500	MP-500 Power Supply